

Dear customer, thank you for purchasing our product. Please read the following instructions carefully and follow them to serve you safely and to your full satisfaction. This will prevent misuse or damage. Avoid unprofessional handling of this appliance and always observe the electrical appliance usage guidelines. Do not hang or cover the luminaire with anything. Keep the instruction manual carefully. Installation must only be carried out by qualified personnel.

TECHNICAL PARAMETERS

	WO8001	WO8002
Voltage	220-240V AC	220-240V AC
Consumption	48W for 4000K, 24W for 3000K and 6000K	60W for 4000K, 32W for 3000K and 6000K
Luminous flux	3360lm for 4000K, 1700lm for 3000K and 6000K	4200lm for 4000K, 2100lm for 3000K and 6000K
Chromaticity	3000K, 4000K, 6000K	3000K, 4000K, 6000K
Coverage	IP20	IP20
LED lifetime	20.000 hours	20.000 hours
Dimensions	380 x 80 mm	490 x 80 mm
Operating temperature	-20°C to 50°C	-20°C to 50°C

INSTALLATION

Switch off the power supply before installation!

1. Insert the dowels into the pre-drilled holes.
2. Remove the rear of the luminaire by turning it and thread the supply cable through the hole in the rear of the luminaire.
3. Screw on the back of the luminaire.
4. Connect the supply cable to the terminal block and make sure that the connection is correct.
5. Rotate to attach the front of the luminaire to the rear.
6. Switch on the power supply.

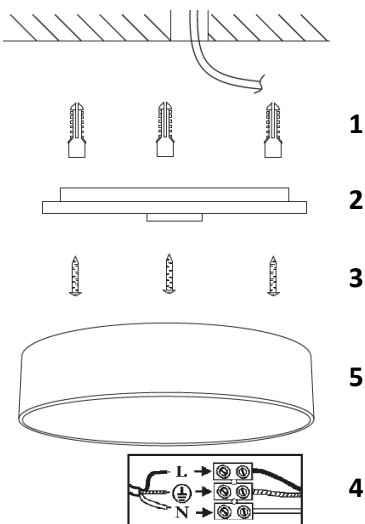

REMOTE CONTROL

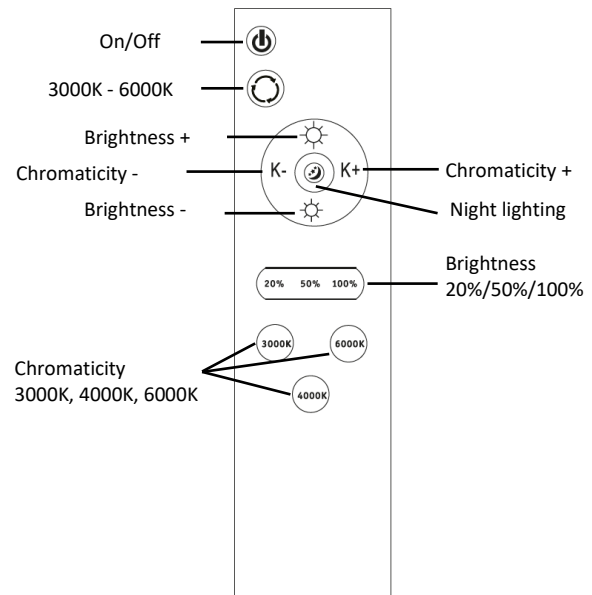

Memory function:

- 1) If you turn on the light with the classic wall switch and leave it on for at least 30sec, then turn it off for at least another 30sec with the wall switch, the last used mode will be lit the next time you turn it on. The same time delays apply for setting the light mode with the remote control and then switching it off and on with the wall switch.
- 2) When switching the light on and off with the remote control, the light always remembers the last mode used, regardless of the time intervals between switching on and off.

The light source of this luminaire is non-replaceable, at the end of its service life the entire luminaire must be replaced and disposed of in a designated place. This product contains a light source that for design reasons cannot be removed for verification and therefore the entire product is considered a light source. The manufacturer is not liable for any damage caused by improper use.

The product has been issued with a CE declaration of conformity in accordance with the applicable regulations. On request from the manufacturer: info@solight.cz, or downloadable from www.solight.cz/en.

